

CONTINENTAL



HYDRAULICS™

CONTINENTAL HYDRAULICS

VER03M

PROPORTIONAL PRESSURE RELIEF VALVES



VER03M - PROPORTIONAL PRESSURE RELIEF VALVES

VERO3M

PROPORTIONAL PRESSURE RELIEF VALVES

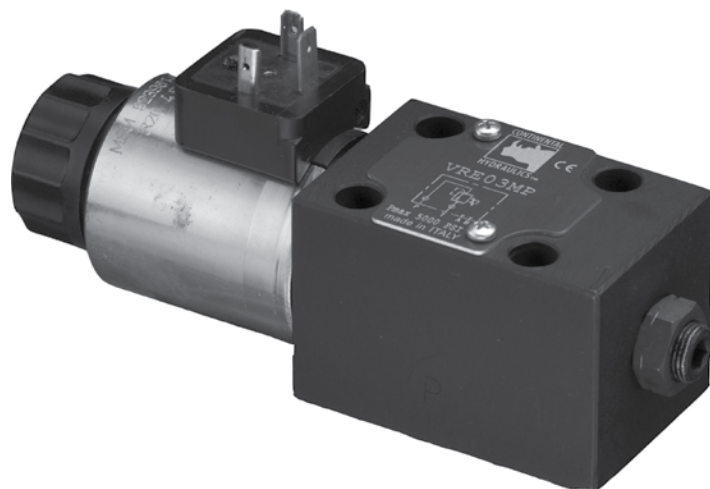

DESCRIPTION

VERO3M is a direct operated proportional relief valve, with mounting in compliance with NFPA/T3.5.1 R2-2002 and ISO 6264:1998 standards.

OPERATIONS

The VERO3M valves are designed to modulate pressure in a hydraulic circuit directly proportional to the input current to the valve.

The valve consists of a poppet, seat, spring and proportional solenoid. The spring and solenoid force acts on the poppet holding the valve closed. When system pressure exceeds the spring and solenoid forces, the valve begins to open and modulate P port pressure by discharging excess flow to tank. System pressure can be changed by changing the current to the solenoid.

There are four pressure ranges available: 70 bar, 140 bar, 210 bar and 350 bar with flow up to 1.32 gpm.

Any back pressure in T port is added to the controlled pressure in P port. The maximum recommended T port pressure is 30 psi while the valve is controlling pressure.

The valve can be driven by a variable current power supply or an external power amplifier card designed to maximize the valve's performance.

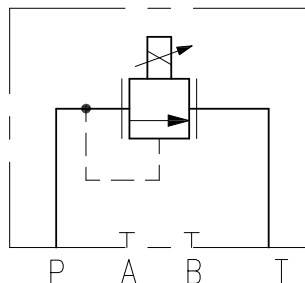

TYPICAL PERFORMANCE SPECIFICATIONS

MAXIMUM OPERATING PRESSURE	P Port	5000 psi	350 bar
	T Port	30 psi	2 bar
MAX FLOW		1.32 gpm	5 l/min
RATED FLOW		0.26 gpm	1 l/min
PRESSURE STAGES	VERO3M-070	10 - 1000 psi	0.7 - 70 bar
	VERO3M-140	16 - 2000 psi	1.1 - 140 bar
	VERO3M-210	26 - 3000 psi	1.8 - 210 bar
	VERO3M-350	40 - 5000 psi	2.8 - 350 bar
MOUNTING SURFACE		NFPA R03 (D03) ISO 6264-03-04-* -97	

STEP RESPONSE @140 BAR	0 → 100%	80 ms	
	100 → 0%	40 ms	
HYSTERESIS	% of Q max	< 5%	
REPEATABILITY	% of Q max	< ± 1.5%	
POWER SUPPLY		12V DC or 24V DC	
CONNECTION		DIN 43650	DT04-2P
PROTECTION	IEC 60529	IP65	IP69K
WEIGHT:	Single Solenoid	3.5 lbs	1.6 Kg

IDENTIFICATION CODE

VER03M - - - **D** - _____ DESIGN LETTER

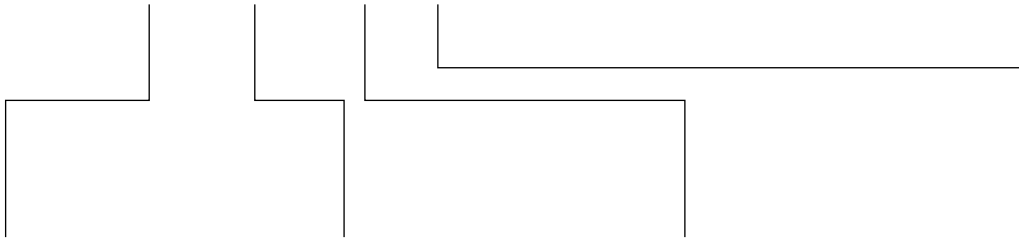

PRESSURE STAGES	
070	10 - 1000 psi (0.7 - 70 bar)
140	16 - 2000 psi (1.1 - 140 bar)
210	26 - 3000 psi (1.8 - 210 bar)
350	40 - 5000 psi (2.8 - 350 bar)

SEAL	
A	Buna (STD)
G	Viton

CONNECTION	
K1	DIN 43650 (STD)
K7	DT04-2P 'Deutsch'

VOLTAGE	
12	12 V DC Solenoid
24	24 V DC Solenoid

TYPICAL ORDERING CODE:
VER03M-210-A-K112D-A

CHARACTERISTIC CURVES

Typical control curves according to the current supplied to the solenoid for all the pressure stages, measured with input flow rate $Q = 1$ l/min. The curves are obtained without any hysteresis and linearity compensation and they are measured without any back pressure in T.

Curves obtained with mineral oil with viscosity of 170 sus (36 cSt) at 122°F (50°C).

PRESSURE GAIN

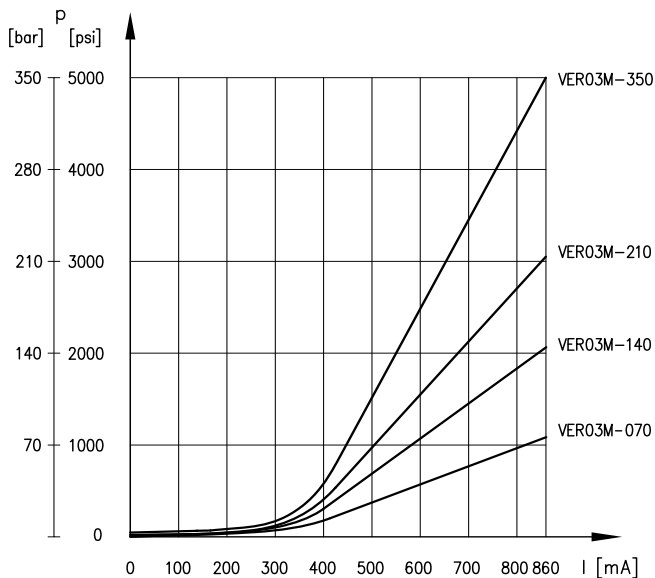

NOTES:

1. The full-scale pressure is set at the factory with a flow rate of 0.26 gpm (1 l/min). The full-scale pressure will increase considerably if the flow rate is higher. See the pressure variation diagram.
2. Curves obtained with current supplied to solenoid, VER03M 24V DC version.

CHARACTERISTIC CURVES

MINIMUM ADJUSTMENT PRESSURE

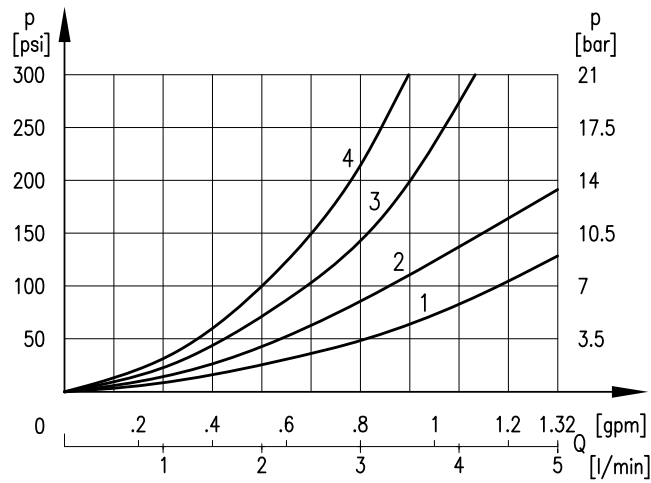

NOTES:

1. Curve obtained with current supplied to solenoid, VER03M 24VDC version.
2. Values obtained with oil viscosity of 170 SUS (36 cSt) at 122°F (50°C).

PRESSURE VARIATIONS

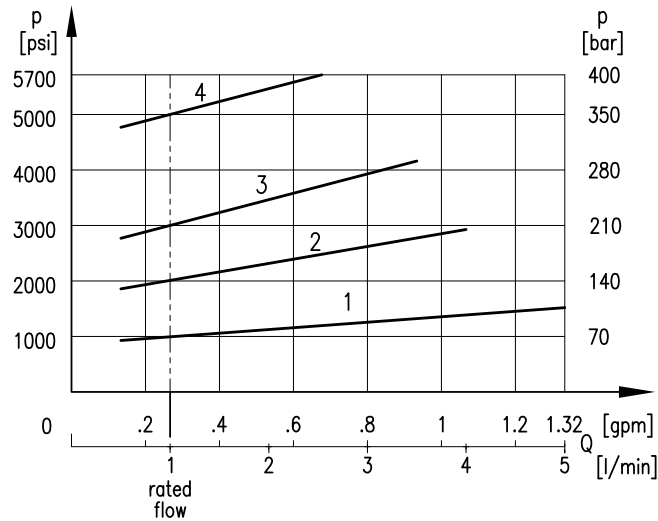

CURVE	VALVE
1	VER03M-070
2	VER03M-140
3	VER03M-210
4	VER03M-350

NOTES:

Full scale pressure is set at Q = .26 gpm (1 l/min).

OVERALL AND MOUNTING DIMENSIONS FOR VER03M

VER03M

Dimensions in mm [IN]

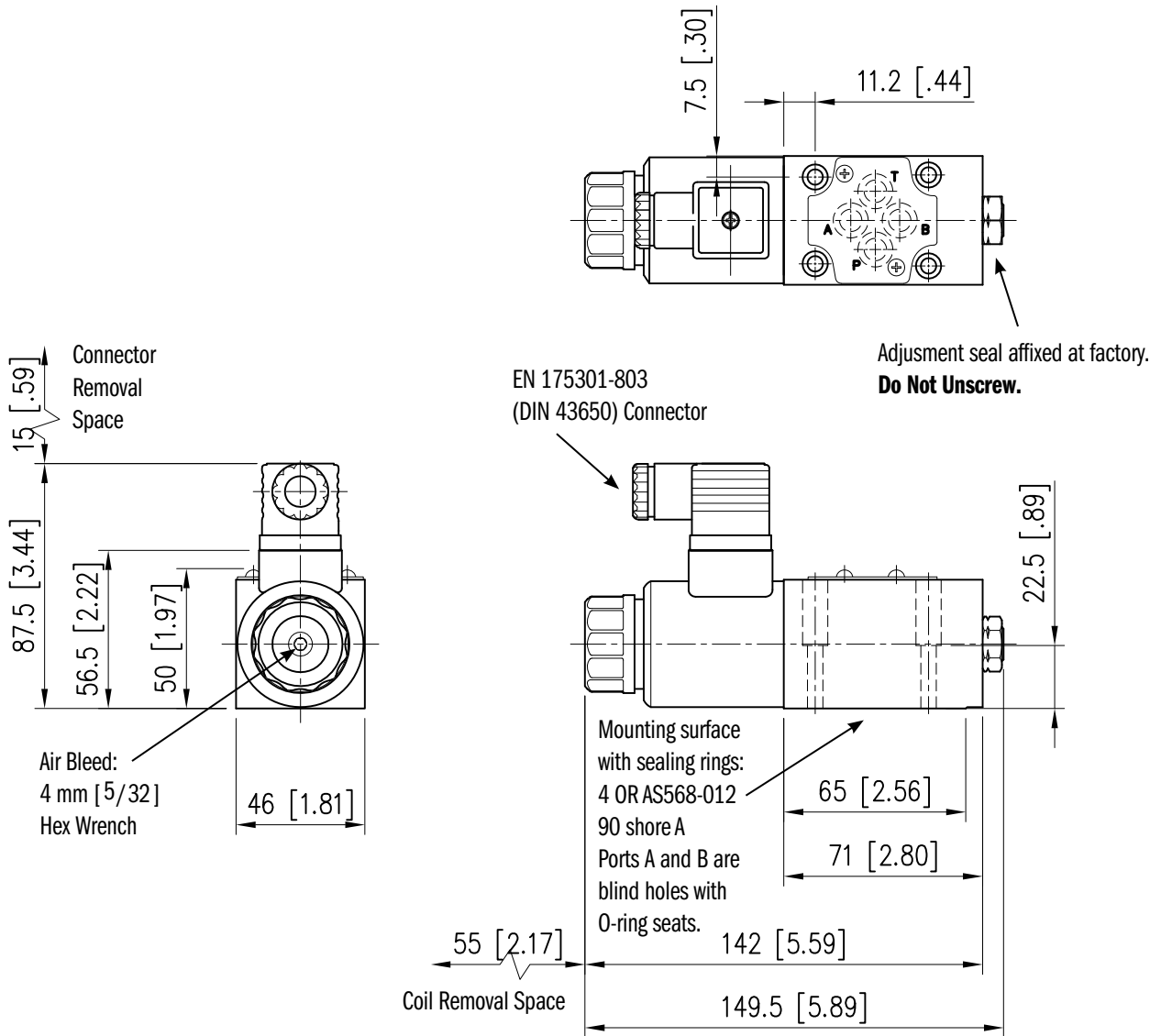

K7 CONNECTION

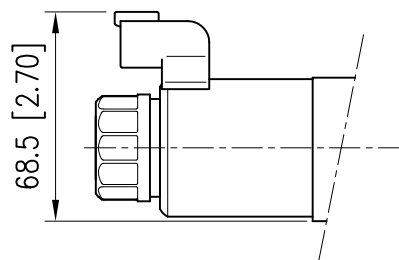

VER03M - PROPORTIONAL PRESSURE RELIEF VALVES

ELECTRICAL CHARACTERISTICS FOR VER03M

The proportional solenoid consists of tube and coil. The coil is mounted on the tube and fastened to it by a ring retainer.

The coils can be mounted in any position depending on the installation requirements.

IP DEGREE

The declared IP degree is guaranteed for all valves only if the connector has been wired and mounted correctly on the coil.

The K7 connection meets DIN 40050-9 which extends the IEC 60529 rating system with an IP69K rating for high-pressure, high-temperature and wash-down applications.

NOMINAL VOLTAGE	V DC	12	24
RESISTANCE AT 68° F	K1	3.66 Ω	17.6 Ω
	K7	4.5 Ω	18.7 Ω
CURRENT AT 68° F	K1	1.88 A	0.86 A
	K7	2.72 A	1.29 A
DUTY CYCLE	100%		
ELECTROMAGNETIC COMPATIBILITY (EMC)	European Directive 2004/108/EC		
IP DEGREE IEC 60529	K1	IP 65	
	K7	IP 69K	
CLASS OF PROTECTION FOR INSULATION	Copper Wire	Class H (356 °F)	
	Coil	Class F (311 °F)	

ACCESSORY ELECTRONICS

Some external digital amplifiers are available to be coupled to the valve for better control and to improve the valve's performance.

See Continental Hydraulics Control Amplifier Catalog for products to match your requirements.

VEA-3F-A: DIN Connector - Black

APPLICATION DATA

FLUIDS

All pressure drops shown on these data pages are based on 170 SUS fluid viscosity and 0.87 specific gravity. For any other specific gravity (G1) the pressure drop (ΔP) will be approx. $\Delta P_1 = \Delta P (G1/G)$. See the chart for other viscosities.

FLUID VISCOSITIES	Cst	10	14.5	32	36	43	54	65	76	86	108	216	324	400
	SUS	60	75	150	170	200	250	300	350	400	500	1000	1500	1900
MULTIPLIER		0.77	0.81	0.97	1.00	1.04	1.10	1.15	1.20	1.24	1.31	1.56	1.72	1.83

Use mineral oil-based hydraulic fluids HL or HM type, according to ISO 6743-4. For these fluids, use NBR seals. For fluids HFDR type (phosphate esters) use FPM seals (code G). For the use of other kinds of fluid such as HFA, HFB, HFC, please consult our technical department.

Using fluids at temperatures higher than 180 degrees F causes the accelerated degradation of seals as well as degradation of the fluids physical and chemical properties.

From a safety standpoint, temperatures above 130 degrees F are not recommended.

RANGE TEMPERATURES:	Ambient	-4 to +130 °F	-20 to +54 °C
	Fluid	-4 to +180 °F	-20 to +82 °C
FLUID VISCOSITY	Range	60 -1900 SUS	10 - 400 cSt
	Recommended	120 SUS	25 cSt
FLUID CONTAMINATION	ISO 4406:1999 Class 18/16/13		

INSTALLATION

We recommend the VERO3MP valve be installed either horizontally or vertically with the solenoid downward. The minimum regulated pressure may vary from the graphs shown on page 3 if the valve is installed vertically with the solenoid upwards.

Bleed the air from the hydraulic circuit. Be sure that the solenoid tube is always full of oil. It may be necessary to vent entrapped air from the solenoid tube in certain applications or after a long shutdown period. The air bleed vent is located on the end of the solenoid tube. See page 4 for the location. Be sure to close the air bleed when the process is complete.

Connect the valve T port directly to the tank. Any back pressure from the tank line will add directly to the controlled pressure. **The maximum allowable back pressure in the tank line under operational conditions is 2 bar.**

Valves are fixed by means of screws or tie rods on a flat surface with planarity and roughness equal to or better than those indicated in the relative symbols. If minimum values are not observed, fluid can easily leak between the valve and support surface.

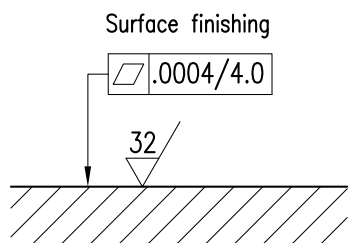

SEAL KIT

BUNA SEAL KIT	1013188
VITON SEAL KIT	1013096

BOLT KITS

BD03-125	Valve Only	1008406
----------	------------	---------

NOTE:

1. Bolt kit consists of: Qty. 4 10-24NC screws
Qty. 4 #10 Lock washer
2. The recommended torque value for fasteners is: 4 lb.ft (5.4 Nm)

SUBPLATES

AD03SPS8S	Aluminum	SAE-08	265801AP
DD03SPS8S	Ductile	SAE-08	265801AI

NOTES:

1. Max pressure for aluminum subplates: 3000 psi
2. Max pressure for ductile subplates: 5000 psi
3. Always verify subplate port size is proper for the application

VERO3M - PROPORTIONAL PRESSURE RELIEF VALVES



POWERFUL
ACCURATE
INNOVATIVE
PRECISE
DURABLE
EFFICIENT
VERSATILE

ABOUT CONTINENTAL HYDRAULICS

Rugged, durable, high-performance, efficient—the reason Continental Hydraulics' products are used in some of the most challenging applications across the globe. With a commitment to quality customer support and innovative engineering, Continental's pumps, valves, power units, mobile and custom products deliver what the markets demand. Continental has been serving the food production, brick and block, wood products, automotive and machine tool industries since 1962. Learn how our products survive some of the most harsh environments.

SALES@CONTHYD.COM

5505 WEST 123RD STREET • SAVAGE, MN 55378-1299 / PH: 952.895.6400 / FAX: 952.895.6444 / WWW.CONTINENTALHYDRAULICS.COM

CONTINENTAL



HYDRAULICS.